



GUESTROOM SPECIALISTS

Hinti GmbH
Hotelsupplies

ALISEO GERMANY
HOTELPERFEKTION





The Londoner

Vereint stilvolle und klassische Tradition. Unsere handgearbeiteten Kunstleder-Accessoires werden an speziell gegossenen Formen unterschiedlichster Gestalt und Größe verarbeitet und erhalten dadurch ihr reiches Erscheinungsbild und ihre Langlebigkeit.

Eine geruchlose, schadstofffreie, wasserabweisende Oberfläche verhindert das Eindringen von Feuchtigkeit. Zusammengehalten wird das hochwertige Material von stabilen und aufwändig gefertigten Nähten. Abgerundete Ecken und kratz-feste Böden runden die dauerhafte Qualität, Raffinesse und Funktionalität des LONDONERs ab.

Die Kollektion erscheint als erlesenes Ensemble, welches mit weiterer, passender Ausstattung aus dem ALISEO Angebot ergänzt werden kann.

Die harmonische, neutrale Farbe Taupe fügt sich unaufdringlich in jede Zimmereinrichtung ein.

The Londoner

Embodies a fine tradition of style and class. Constructed around sturdy forms of versatile shapes and sizes our hand-crafted faux leather type accessories provide a rich appearance and long-lasting service.

Water resistant surface is fixed to the surface via odorless Green strength non-toxic adherents. Strong durable bond, superior ribbed stitching, turned corners, and non-scratch bottoms provide an enduring statement of quality, sophistication and function.

The assortment comes as a pre-arranged ensemble that can be expanded with additional complementary accoutrements.

Attractive neutral taupe color complements any guestroom decor.



190001

Tablett

Tray



190003

Ablagebehälter
mit zwei Fächer

Sachet Box
with two compartments



190002

Ablagebehälter
mit zwei Fächer

Sachet Box
with two compartments





190005

Glas-/Tassenuntersetzer
für Gläser/Tassen/Teebeutel

Coaster
for cups/glasses/tea bags



190004

Glas-/Tassenuntersetzer
Coaster



190006

Eiswürfelbehälter, 1 Liter
mit Deckel und Zange. Edelstahl

Ice Cube Container, 1 litre
with lid and tongs. Stainless steel





190030

Tischauflage
mit magnetischer Klemmschiene

Desk Pad
with magnetic fold

405 | 14
500



190029

Rechnungsmappe
mit magnetischer Klemmschiene
und Stifthalter

Bill Presenter
with magnetic fold and pen holder



190027

Info-Mappe A5
mit 2-Ring-Mechanik
Service Binder A5
with two ring clamp



190028

Info-Mappe A4
mit 2-Ring-Mechanik
Service Binder A4
with two ring clamp





190014

TV-Mappe mit Fach für Fernbedienung und Sichtfenster für Programmliste
Remote Control Binder
with compartment for TV channel list



190015

Fernbedienungsständer
Remote Control Holder



190018

Info-Wandhalter
z.B. für Wäscheservice
Service Wall Holder
e.g. for laundry information





190008

Utensilienbox
Storage Tray



190009

Utensilienbox
mit drei Fächer
Storage Tray
with three compartments



190011

Notizblockunterlage
mit Vertiefungen für Block und Stift
Note Pad Mat
with cut-outs for note pad and pen



190012

Notizblockhalter
mit magnetischer Klemmschiene
und Stifthalter
Note Pad Holder
with magnetic fold and pen holder





190013

Tischuhr - batteriebetrieben
mit Weckfunktion und Beleuchtung
Table Clock - Battery-Powered
with alarm and lighting



190010

Zettelbox
Memo Box





190007

Schatulle
mit Schubfach
Storage Box
with drawer



190016

Kosmetiktuchspender
mit magnetischer Bodenklappe
Tissue Dispenser
with magnetic trap at the bottom



190017

Kosmetiktuchspender
mit magnetischer Bodenklappe
Tissue Dispenser
with magnetic trap at the bottom







190022

Korb
z.B. für Schuhe
Basket
e.g. for shoes

225 | 420
370



190019

Kleiderbürste
Holz mit Aufhängeschlaufe
Clothes Brush
wood with hanger

380

190020

Schuhlöffel
Holz mit Aufhängeschlaufe
Shoe Horn
wood with hanger

380

190021

Schuhlöffel
Metall
Shoe Horn
metal

393



THE LONDONER



190023

**Zeitschriftenständer
mit zwei Fächer**

Magazine Holder
with two compartments

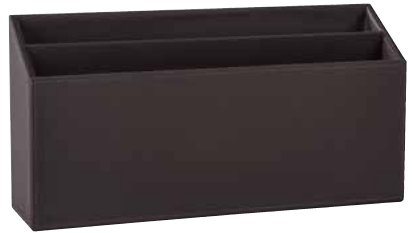

190024

**Zeitschriftenbox
mit zwei Fächer**

Magazine Storage
with two compartments



190026

**Abfallbehälter - 10 L
mit herausnehmbarem Metalleinsatz**

Waste Bin - 10 L
with removable metal liner



190025

**Abfallbehälter - 9 L
Metall mit abnehmbarer Kunstleder-Ummantelung**

Waste Bin - 9 L
Metal with removable faux leather casing





Die hochwertige Ausarbeitung beinhaltet erlesene Details und die stabilen und aufwändig gefertigten Nähte eine lange Lebensdauer.

Premium quality designs features exquisite details and rugged ribbed stitching for extended longevity.

Die edle, absichtlich einfach gehaltene Velourslederimitat-Fütterung verstärkt die exklusive, elegante Erscheinung.

Faux suede lining for an elegant finishing touch.



FLECKENENTFERNUNG

Das Lederimitat ist wasserabweisend und bedarf daher nur einer minimalen Pflege. Es kann einfach mit einer milden Seife gereinigt werden. Verwenden Sie KEINE aggressiven Reinigungsmittel oder auf Säure basierende Chemikalien.

Befeuchten Sie ein sauberes, weiches Tuch mit etwas Wasser und Seife. Wringen Sie ggf. überschüssiges Wasser aus, um die Oberfläche nicht unnötiger Feuchtigkeit auszusetzen. Wischen Sie die Flecken mit dem feuchten Tuch sanft ab. Reinigen Sie den Bereich mit einem sauberen, trockenen und weichen Tuch nach. Um unnötige Spuren zu vermeiden, sollte die Oberfläche nur mit gerade so viel Wasser benetzt werden, dass es zum effektiven Entfernen der Flecken ausreicht. Anschließend sollte das Accessoire unverzüglich getrocknet werden.

STAIN REMOVAL

The faux leather is non-porous and therefore requires little maintenance. It can be easily cleaned with a mild soap solution. Do NOT use harsh detergents or acidic based chemical solutions.

Dampen a clean soft rag with soapy water; squeeze-off the excess water to avoid over-saturating the surface. Gently wipe the stains clean with the damp rag.

Wipe off the area with a clean dry soft rag. The trick is to dampen the leather with minimal moisture to allow efficient cleaning and allow it to dry quickly to avoid damage.





IVANA

... a Personal Touch

Beeindruckende, schokoladenbraune Kunstleder-Accessoires verleihen dem Gästezimmer eine persönliche Note.

IVANA wurde exklusiv für Aliseo von Winfried Noth entworfen und bringt ein elegantes, schickes Design in das moderne Gästezimmer von heute. Die handgefertigten Kunstleder-Produkte haben stabile, aufwändig gefertigte Nähte, abgerundete Ecken und kratz feste Böden. Erstklassige Qualität wird durch die wasserabweisende, gemaserte und schadstofffreie Oberfläche gewährleistet.

Ihre fließenden und funktionalen Formen machen die IVANA Kollektion zu der perfekten Wahl für zeitgemäße Ansprüche. Eine ausdrucksstarke Ergänzung, die der Gast zu schätzen weiß.

IVANA

... a Personal Touch

Distinctive chocolate brown faux leather accoutrements bring a fashionable personal touch to the guestroom.

Designed exclusively for Aliseo by Winfried Noth, the Ivana collection provides an elegant chic design to today's modern guestroom. Hand-crafted construction features superior ribbed stitching, turned corners and non-scratch bottoms. Durable water-resistant pebble grain surface is affixed via an odorless non-toxic Green strength adherent ensuring long lasting service and effortless care.

Sculptural and functional forms that streamline your guestroom presentation, the Ivana Collection is the perfect accessory solution for a modern address. An expressive most welcome addition that enhances your guest's experience.



190034

Tablett
Tray

200 | 35
460

190035

Ablagebehälter
mit zwei Fächer

Sachet Box
with two compartments

85 | 65
155

190032

Kaffeekapselbehälter
für 2 oder 4 Kapseln

Coffee Capsule Holder
for 2 or 4 capsules

135 | 65
120



190037

Eiswürfelbehälter, 1 Liter
mit Deckel, Zange und Abtropfschale. Edelstahl
Ice Cube Container, 1 litre
with lid, tongs and drip grid. Stainless steel



190038

Kosmetiktuchspender
mit magnetischer Bodenklappe
Tissue Dispenser
with magnetic bottom flap



190039

Kosmetiktuchspender
mit magnetischer Bodenklappe
Tissue Dispenser
with magnetic bottom flap





190041

Tischauflage
mit magnetischer Klemmschiene

Desk Pad
with magnetic fold





190040

TV-Mappe mit Fach für Fernbedienung
und Sichtfenster für Programmliste

Remote Control Binder
with compartment for TV channel list



190042

Info-Mappe A4
mit 2-Ring-Mechanik

Service Binder A4
with two ring clamp





190033

Zeitschriftenständer
Magazine Holder



190036

Abfallbehälter - 9 L
mit herausnehmbarem Metalleinsatz
Waste Bin - 9 L
with removable metal liner





Stabile, aufwändig gefertigte Nähte und wasserabweisende, gemaserte Oberfläche.

Durable ribbed stitching and water resistant pebble-grain surface.



Innenfutter aus Velourslederimitat verleiht ein elegantes Aussehen.

Suede lining provides an elegantly finished touch.



Stylishes, platzsparendes Serviertablett.

Stylish space-conscious service tray.



Kaffee kapselbehälter: wendbare Einlage für 2 oder 4 Kapseln in verschiedenen Größen.

Coffee pad holder: reversible insert accommodates 2 or 4 capsules in various sizes.

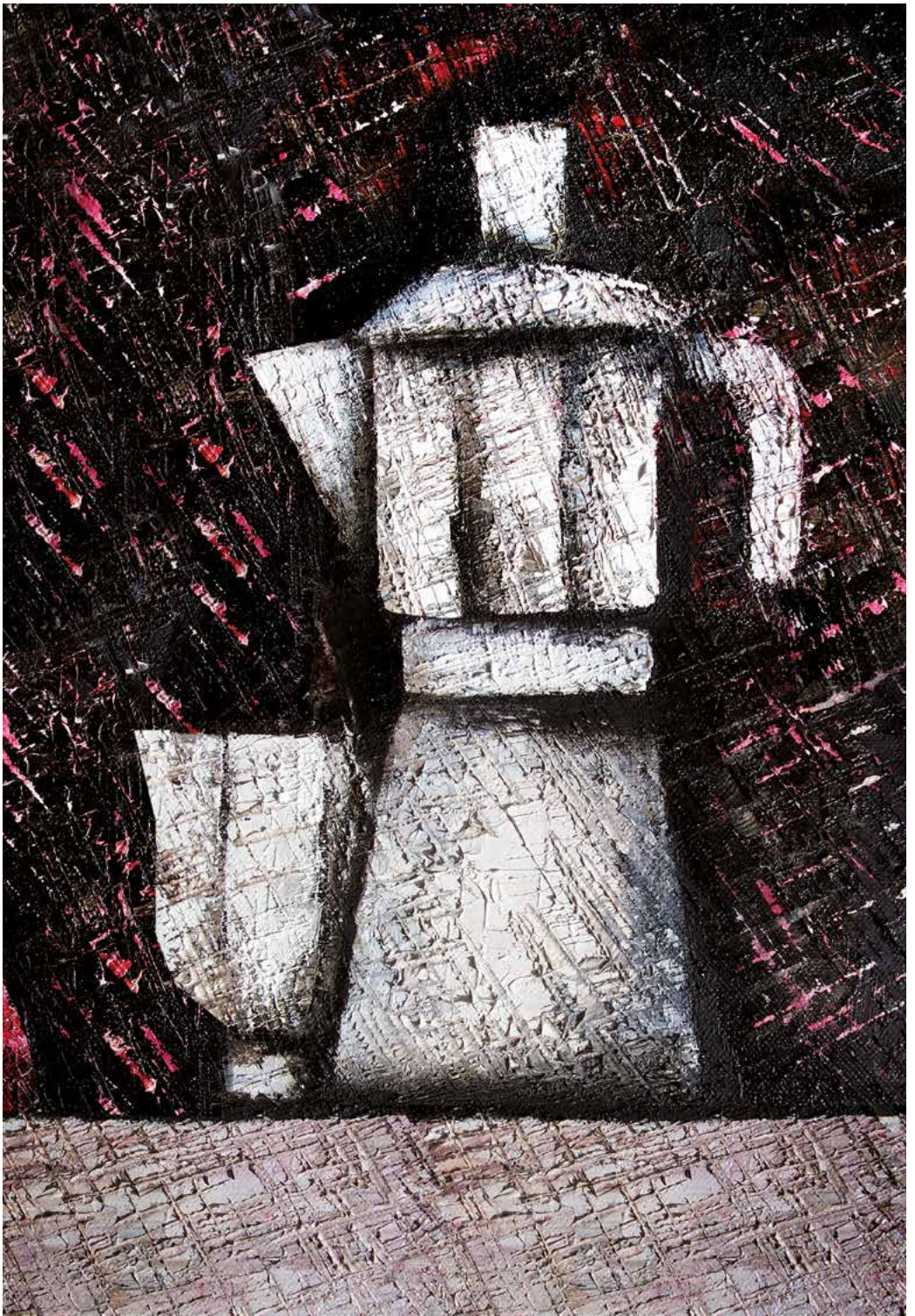



* Abgebildet mit Tablett Manila und Behälter Puzzle
Shown with tray Manila and Puzzle box

- Platzsparendes 0,5 Liter Design mit energieeffizientem 1000 Watt Heizelement.

0.5 liter space-saving design features an energy efficient 1,000 watt heating platform.

- Abschaltautomatik und Trockenlaufsicherung
Auto shut-off und boil dry protection

*Smaller is Smarter -
water & energy saving*

MINI

0,5 Liter Füllmenge
Integriertes Heizelement
Kabellos, 360° drehbar
Abschaltautomatik
Trockenlaufsicherung
Kontrollleuchte
Deckel mit Sicherheitsverriegelung
Edelstahlgehäuse
Glattes Kabel mit Schweizer Stecker

0.5 litre capacity
Integrated heating element
Cordless, 360° rotation
Automatic shut-off
Boil dry protection
Indicator light
Lid with safety interlock
Stainless steel housing
Straight cord with Swiss plug



220-240 V, 50/60 Hz 1000 W

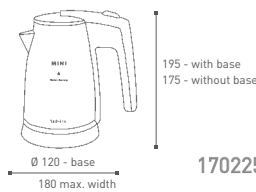

170225

chrom gebürstet/schwarz
brushed chrome/black



- Edelstahl gebürstet
Brushed stainless steel construction

Smaller is Smarter - water & energy saving

1. Ergonomisch geformter Kunststoff-Griff (bleibt angenehm kühl) mit beleuchtetem Ein-/Ausschalter
2. Geringe Standfläche durch 0,5 L Design Edelstahlgehäuse, Oberfläche chrom gebürstet
3. 360° Basisstation mit Strix-Controller für die Sicherheit der Gäste
4. Verriegeltester Sicherheitsklapdeckel, öffnet auf Knopfdruck
5. Schmale Ausgusstülle - zum einfachen, tropfenfreien Ausgießen



1. Safety-grip handle with illuminated power switch
2. Cylindrical low-profile 0.5 liter footprint; stainless steel construction with brushed surface finish
3. 360° STRIX interface platform ensures guest's safety while optimizing performance
4. Sturdy interlocking safety lid
5. Easy pour spout with wide mouth fill



MINI



Alle Aliseo Wasserkocher verfügen über den patentierten STRIX oder OTTER-Schutzmechanismus. Dieser gewährleistet die automatische Abschaltung bei Erreichen des Kochvorgangs, bei Entnahme des Behälters von der Basisstation und den Trockengehschutz. Eine maximale Sicherheit für die Gäste.

All Aliseo kettles incorporate patented STRIX or OTTER controls ensuring auto shut-off, boil dry protection and steam shut-down functions for maximum guest safety.

1.



2.



3.



SPACE OASIS

Simply Perfect



MINI TRAY ENSEMBLE

*Eco-luxe Effizienz kombiniert Wasser- und Energiesparfunktionen auf kleinster Fläche
... eine sinnvolle Zusammenstellung*

*Eco-luxe efficiency combines water and energy saving functions in a small space
... It all makes sense*



3 IN ONE



Schwarz-weiße Keramiktassen
Black/White Ceramic Mugs



BRIDGE TRAY
Hochwertiges, robustes Bambusholz
Schubfach aus langlebigem Melamin
Elegantly finished bamboo construction
Durable melamine condiment tray



MINI
Wassersparendes 0,5 L Design
0,5 liter water- saving design

SPACE OASIS

Wasserkocher-Tablett-Set
Water Kettle Tray-Set **170261**

Holztablett
Bridge Tray **170254**

Tasse
Mug **170258**

MINI Wasserkocher
chrom gebürstet / schwarz
Weitere Information siehe Seite 3

BRIDGE TRAY, Holztablett mit Schubfach
260 x 44 x 160 mm (B x H x T)
Material: Bambus und Melamin
mahagoni/matt schwarz

Zwei Keramik-Tassen
250 ml
schwarz, innen weiß
Höhe 100 mm, Ø 85 mm

MINI Water Kettle
brushed chrome / black
Further information on page 3

BRIDGE TRAY, wooden tray with drawer
260 x 44 x 160 mm (W x H x D)
Material: bamboo and melamine
mahogany / matt black

Two Ceramic Mugs
250 ml
black, inside white
Height 100 mm, Ø 85 mm

Tea Time



WELCOME TRAY SOLUTION

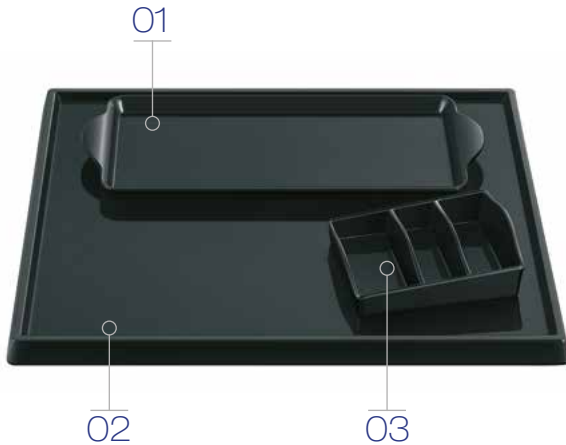

WELCOME TRAY SOLUTION

Tabletset
Material: Melamin
mit Porzellan-Optik

Tray set
Material: Melamine
with porcelain optic

Farboptionen:

schwarz



black

elfenbein



ivory

weiß



white

Colour Options

Komplettes Set
Complete Set

170229

schwarz
black

170233

elfenbein
ivory

170237

weiß
white

Grundtablett
Base Tray

170226

schwarz
black

170230

elfenbein
ivory

170234

weiß
white

Serviertablett
Serving Tray

170227

schwarz
black

170231

elfenbein
ivory

170235

weiß
white

Produktablage
Sachet Tray

170228

schwarz
black

170232

elfenbein
ivory

170236

weiß
white

01. Serviertablett
324 x 21 x 131
Serving tray
324 x 21 x 131

02. Grundtablett
400 x 20 x 330
Base tray
400 x 20 x 330

03. Produktablage
130 x 40 x 100
Sachet tray
130 x 40 x 100

EcoSmart
Energy Saving, 1200 W



* Abgebildet mit Welcome Tray
Shown with Welcome Tray

EMPIRE

0,8 Liter Füllmenge
Integriertes Heizelement
Kabellos, 360° drehbar
Abschaltautomatik
Trockenlaufschutz
Kontrollleuchte
Deckel mit Verriegelung
Edelstahlgehäuse
Glattes Kabel mit Schweizer Stecker

0.8 litre capacity
Concealed heating element
Cordless, 360° rotation
Automatic shut-off
Boil dry protection
Indicator light
Lid with safety interlock
Stainless steel housing
Straight cord with Swiss plug



220-240 V, 50/60 Hz 1000-1200 W



170 - with base
150 - without base

170195

chrom/schwarz
chrome/black



■ Elegante verchromte Oberfläche
Elegant chrome finish



* Abgebildet mit Welcome Tray und Behälter Puzzle
Shown with Welcome Tray and Puzzle boxes

SUNRISE

1,0 Liter Füllmenge
Integriertes Heizelement
Kabellos, 360° drehbar
Auswechselbares Feinsieb
Abschaltautomatik
Trockentaufsicherung
Kontrollleuchte
Füllstandsanzeige außen
Deckel mit Verriegelung
Hitzebeständiges, pflegeleichtes
Kunststoffgehäuse
Glattes Kabel mit Schweizer Stecker

1.0 litre capacity
Concealed heating element
Cordless, 360° rotation
Replaceable filter
Automatic shut-off
Boil dry protection
Indicator light
External level indicator
Lid with safety interlock
Heat resistant, easy care
plastic housing
Straight cord with Swiss plug



220-240 V, 50 Hz 1850-2200 W

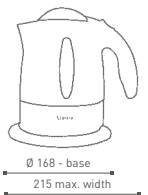

210 - with base
190 - without base

170199

schwarz/chrom
black/chrome

170198

weiß/silber
white/silver





* Abgebildet mit Welcome Tray und Behälter Puzzle
Shown with Welcome Tray and Puzzle boxes

FIZZ

- 1,1 Liter Füllmenge
- Integriertes Heizelement
- Kabellos, 360° drehbar
- Auswechselbares Feinsieb
- Abschaltautomatik
- Trockentaufsicherung
- Kontrollleuchte
- Füllstandsanzeige außen
- Deckel mit Verriegelung
- Hitzebeständiges, pflegeleichtes Kunststoffgehäuse
- Glatte Kabel mit Schweizer Stecker

- 1.1 litre capacity
- Concealed heating element
- Cordless, 360° rotation
- Replaceable filter
- Automatic shut-off
- Boil dry protection
- Indicator light
- External level indicator
- Lid with safety interlock
- Heat resistant, easy care plastic housing
- Straight cord with Swiss plug



220-240 V, 50 Hz 1000-1200 W



170201

schwarz
black

170200

elfenbein
ivory





XUMA



* Abgebildet mit Ablagebehälter Puzzle
Shown with Puzzle boxes

XUMA

Grundtablett
Material: Acryl

Base Tray
Material: Acrylic

400 x 6 x 230 mm

170213 silber
silver



* Abgebildet mit Tablett Xuma und Behälter Puzzle Tassen sind Dekoration

Shown with tray Xuma and Puzzle boxes
Cups are decoration

FUSION

1,0 Liter Füllmenge
Integriertes Heizelement
Kabellos, 360° drehbar
Auswechselbares Feinsieb
Abschaltautomatik
Trockenlaufsicherung
Kontrollleuchte
Füllstandsanzeige außen
Deckel mit Verriegelung
Hitzebeständiges, pflegeleichtes
Kunststoffgehäuse mit
Edelstahlmantelung
Glattes Kabel mit Schweizer Stecker

1.0 litre capacity
Concealed heating element
Cordless, 360° rotation
Replaceable filter
Automatic shut-off
Boil dry protection
Indicator light
External level indicator
Lid with safety interlock
Heat resistant, easy care
plastic housing with
stainless steel casing
Straight cord with Swiss plug



220-240 V, 50 Hz 1850-2200 W



213 - with base
214 - without base

Ø 140 - base
210 max. width

170196

Edelstahl glänzend/schwarz
shiny stainless steel/black

170197

Edelstahl gebürstet/schwarz
brushed stainless steel/black



■ Edelstahl gebürstet
Brushed stainless steel



Das platzsparende, quadratische Tablett ist robust, kompakt und praktisch. Gefertigt aus ABS mit Holzstruktur ist die TEA STATION eine attraktive, kostengünstige Alternative. Sie bietet Platz für Aliseo MINI und FUSION Wasserkocher. Eine perfekte „All in ONE“ Lösung für jedes Hotelzimmer.

Space-conscious square platform is durable, compact and practical. Fabricated from ABS with a simulated wood grain finish, the TEA STATION is an attractive cost-saving alternative. Accommodates Aliseo's MINI and Fusion kettles. An "All in ONE" sensible solution.



* Abgebildet mit Wasserkocher FUSION
[Edelstahl glänzend]

Shown with kettle FUSION
(shiny stainless steel)



TEA STATION

Langlebige, schwarze ABS-Konstruktion
mit einzigartiger Holzstruktur-Oberfläche
Wärme-, wasser-, flecken- und kratzresistent
Aussparung (ø 145 mm / Tiefe 19 mm) passend für
Basisstation von Wasserkocher MINI und FUSION
Anti-Diebstahl-System für Wasserkocher
– das Kabel ist fest am Tablett angebracht
Mulden für Kaffeelöffel und Teebeutel
Abtropfschale mit Abtropfgitter aus Edelstahl
4 möbelschonende Silikonfüße
Tablett 258 x 40 x 258 mm (B x H x T)

Durable black ABS construction
Attractive simulated wood grain finish
Heat, water, stain & scratch resistant
Recessed platform (ø 145 mm / depth 19 mm)
for MINI and Fusion kettles
Theft-proof cord pass through
Open condiment storage & grooved tea bag slots
Recessed drip reservoir with stainless grill cover
4 corner silicone furniture bumpers
Tray 258 x 40 x 258 mm (W x H x D)

*Passend nur zu Wasserkocher MINI & FUSION
For MINI & FUSION Kettles only*



170266 Tablett mit Wasserkocher FUSION (Edelstahl glänzend)
Tray with FUSION kettle (shiny stainless steel)

170269 Tablett mit Wasserkocher FUSION (Edelstahl gebürstet)
Tray with FUSION kettle (brushed stainless steel)

170272 Tablett mit Wasserkocher MINI
Tray with MINI kettle

* Abgebildet mit schwarz-weißen Keramiktassen
Shown with optional black/white ceramic mugs

170258 Keramiktasse, 250 ml, Höhe 100, Ø 85 mm
Ceramic Mug, 250 ml, height 100 mm, Ø 85 mm

* Abgebildet mit Wasserkocher MINI
Shown with kettle MINI



PUZZLE *Mix & Match*



03

STEPS

OF THE MANILA & PUZZLE SOLUTION

01

MANILA TRAY & PUZZLE BOX

MANILA



MANILA Holztablett

Die schlichte Eleganz dieses hochwertigen Tablettts entsteht durch seine abgerundeten Ecken und durch die natürliche Struktur von Bambusholz.

MANILA Wooden Tray

A simple elegant hospitality set with etched wooden compartments allows for a flexible hospitality presentation.

PUZZLE



PUZZLE Ablagebehälter

Attraktive Ablagebehälter in Porzellan-Optik können spielerisch in die dafür vorgesehenen Mulden des Holztablettts integriert werden und passen als Accessoire auch ergänzend zu anderen Tablett-Sets.

PUZZLE Sachet Box

Attractive porcelain-optic boxes can be neatly integrated into etched wooden compartments or used to complement other tray presentations.

MANILA

Holztablett
Material: Bambus

Wooden Tray
Material: Bamboo

Farboptionen
Colour Options

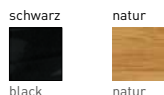

360 x 20 x 260 mm

170221 natur natur

170222 schwarz black

310 x 20 x 180 mm

170223 natur natur

170224 schwarz black

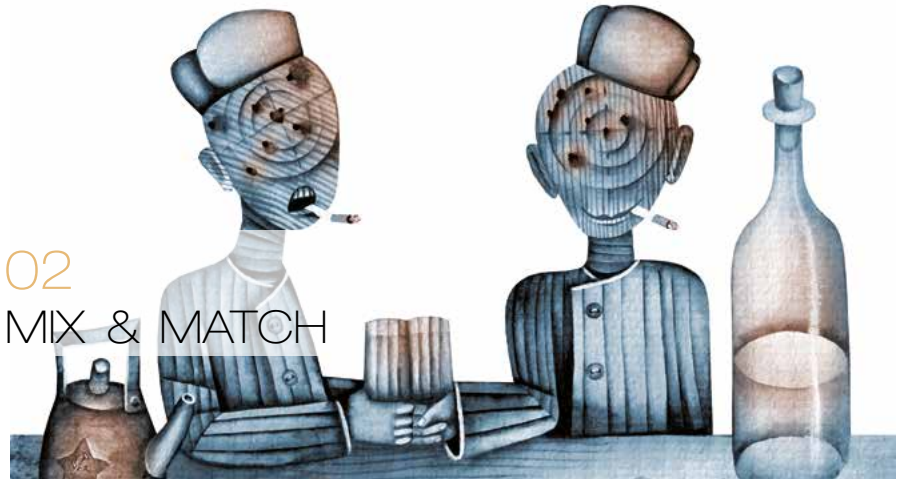

02 MIX & MATCH

03 VARIETY OF COMBINATIONS



PUZZLE

Ablagebehälter
Material: Melamin
mit Porzellan-Optik

Sachet Box
Material: Melamine
with porcelain optic

Farboptionen
Colour Options

schwarz



black

elfenbein



ivory

weiß



white

151 x 55 x 76 mm

170240 schwarz
black

170238 elfenbein
ivory

170242 weiß
white

76 x 55 x 76 mm

170241 schwarz
black

170239 elfenbein
ivory

170243 weiß
white

Everything in Place



- Aussparungen/Ausschnitte für Tassen und Löffel
Cut-outs for cups and spoons



- Ausschnitt für das Anschlusskabel
des Wasserkochers
Cut-out for water kettle cable

THE ORGANIZER

Ablagesystem
4 Fächer für Tee / Zucker /
Kaffee / Abfall
2 Aussparungen für Tassen
2 Ausschnitte für Löffel
Ausschnitt für Kabel
Material: MDF

Storage Tray
4 chests for tea / sugar /
coffee / waste
2 cut-outs for cups
2 cut-outs for spoons
Cut-outs for cable
Material: MDF

370 x 104 x 220 mm

170220 schwarz
black

IRONING SOLUTIONS

... at your service



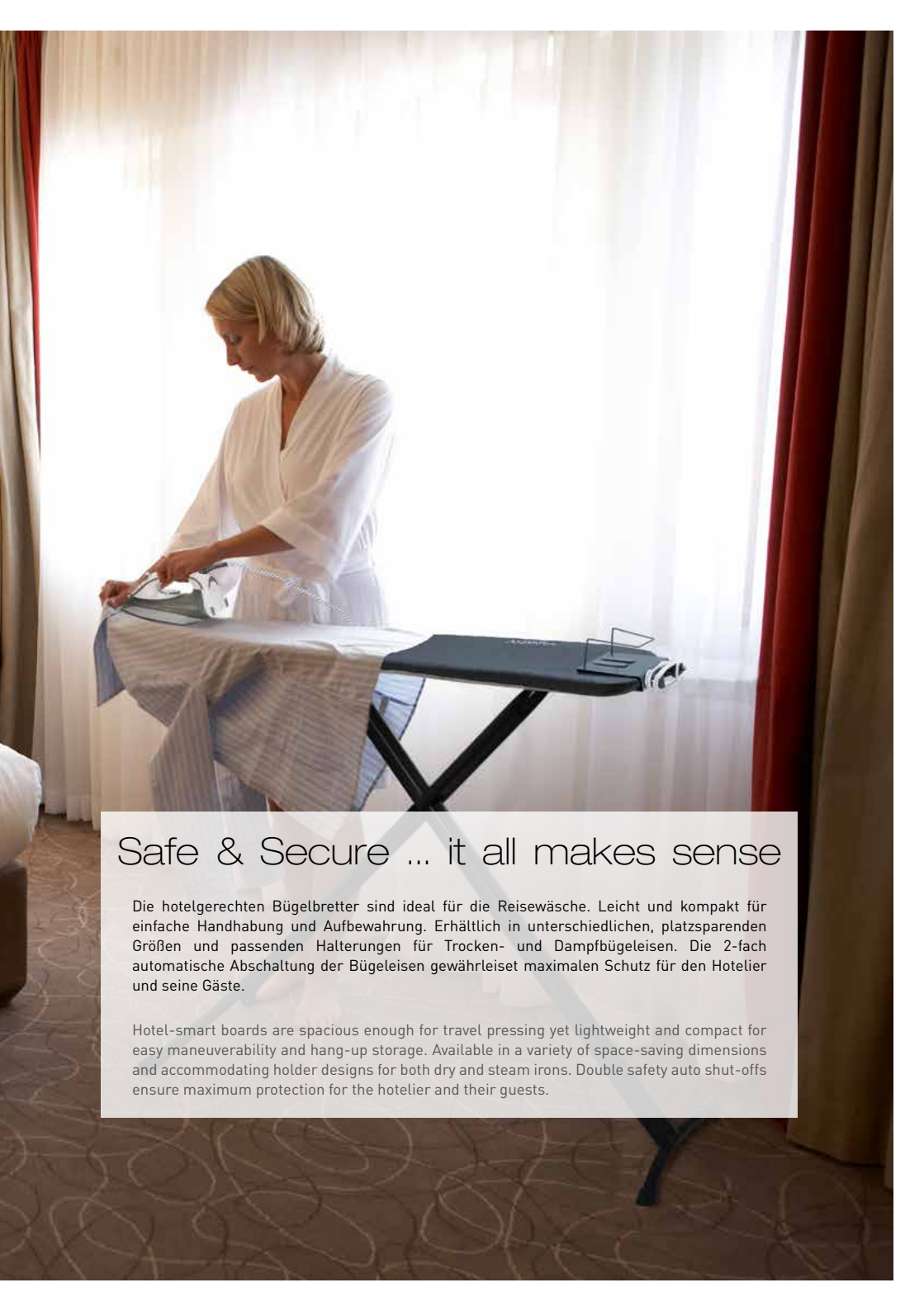

Safe & Secure ... it all makes sense

Die hotelgerechten Bügelbretter sind ideal für die Reisewäsche. Leicht und kompakt für einfache Handhabung und Aufbewahrung. Erhältlich in unterschiedlichen, platzsparenden Größen und passenden Halterungen für Trocken- und Dampfbügeleisen. Die 2-fach automatische Abschaltung der Bügeleisen gewährleistet maximalen Schutz für den Hotelier und seine Gäste.

Hotel-smart boards are spacious enough for travel pressing yet lightweight and compact for easy maneuverability and hang-up storage. Available in a variety of space-saving dimensions and accommodating holder designs for both dry and steam irons. Double safety auto shut-offs ensure maximum protection for the hotelier and their guests.



ENGINEERED FOR PERFORMANCE



- Automatische Abschaltung für mehr Sicherheit - horizontal nach 30 Sekunden / vertikal nach 8 Minuten
- Textilfreundliche Anti-Haft-Keramiksohle
- Maximale Wärmeregulierung auf 200° C schützt Textilien bei Fehlbedienung
- Einfache Befüllung des Wassertanks mit Wasserstandsanzeige, Kapazität 200 ml/6.8 oz.

- Automatic Hotel safety shut-off - horizontal after 30 seconds/ vertical after 8 minutes
- E-Z-glide non-stick CERAMIC soleplate
- Dial Fabric Control locks out at 200° C – guards against accidental scorching of fabric
- Easy front fill clear water tank: capacity 200 ml/6.8 oz.



01



02



03

STEAMWORKS

Hotel-Dampfbügeleisen
Energiesparend - 1650-2000 W
2-fach automatische Abschaltung
Anti-Haft-Keramiksohle
Anti-Kalk- und Anti-Tropf-System
Selbstreinigungssystem
Gewicht 1,1 kg

Hotel steam iron
Energy saving - 1650-2000 W
Double safety automatic shut-off
Non-stick ceramic soleplate
Anti-calc and anti-drip system
Self cleaning system
Weight 1.1 kg

Intertek GS CE 220-240 V, 50/60 Hz 1650-2000 W

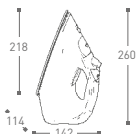

160170

weiß/silber, Schweizer Stecker
white/silver, Swiss plug

- 01. Fingertip-Dampffunktion
Finger-tip Steam Function
- 02. Dampffunktion wahlweise mit komprimiertem Dampf oder Wasserspray
Full-range spray adjustment with temperature control light
- 03. Temperatúrauswahl lässt sich auf unterschiedliche Textilien individuell einstellen
Rotating Fabric Control Dial



SAHARA - Works When Dry



EcoSmart
Energy Saving, 1100 W



SAHARA

Hotel-Trockenbügelleisen
EcoSmart - 900-1100 W
2-fach automatische Abschaltung
Temperaturregler
Anti-Haft-Keramiksohle
Gewicht 0,8 kg

Hotel dry iron
EcoSmart - 900-1100 W
Double safety automatic shut-off
Fabric control dial
Non-stick ceramic soleplate
Weight 0.8 kg

01. Anti-Haft-Beschichtung
E-Z glide non-stick coating

02. 2-fach automatische Abschaltung
Double safety automatic shut-off

CE 220-240 V, 50/60 Hz 900-1100 W

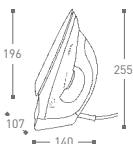

160173

silber/champagne, Schweizer Stecker
silver/champagne, Swiss plug



EU-Schuko-Elektroanschluss mit
Netz kabel und Schweizer Stecker
Integrated EU Schuko socket and
extension cord with Swiss plug

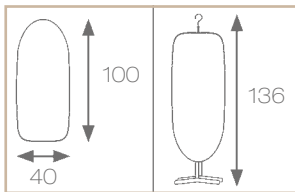

160179 SURF CENTER SAHARA
Bügelbrett mit Trockenbügelseisen
Ironing board with dry iron

160166 SURF CENTER STEAMWORKS
Bügelbrett mit Dampfbügelseisen
Ironing board with steam iron

160146 SURF BOARD
Bügelbrett ohne Bügeleisenhalterung
Ironing board without iron safety cradle

SURF CENTER

Bügelbrett mit Sicherheitshalterung
Feuerfester, gepolsterter Bezug
Aufhängehaken
Stabiles Gestell mit Transportsicherung
Material Gestell: Stahlrohr
Pulverbeschichtung, silber

Ironing board with safety cradle
Anti-Fire cover with foam underlay
Suspension hook
Sturdy frame with transport safety lock
Material legs: tubular steel
Powder coated silver finish

Gewicht / Weight

Bügelbrett / Board Surf	4,9 kg
Halterung / Holder	0,4 kg
Bügelseisen / Iron Sahara	0,8 kg
Bügelseisen / Iron SteamWorks	1,1 kg
Gesamt / Total	6,1 / 6,4 kg

Für Sahara oder SteamWorks
Hotel-Bügeleisen

For Sahara or SteamWorks
Hotel Irons



Höhenverstellbar 84 - 87 - 90 cm
Height adjustment 84 - 87 - 90 cm

Diebstahlsicher – Kabel ist fest mit
dem Bügelbrett verbunden

Anti-theft protection - cable
guard secured through the board



ALISEO HANG-UP

Bügeleisenhalterung
 Hitzebeständige Rückwand
 Montage mit oder ohne Haken für
 Bügelbrett

Hang-up organizer
 Heat resistant back plate
 Mounted with or without
 board hanger

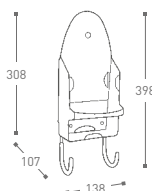

160130 für Trockenbügelleisen Sahara
 schwarz
 for dry iron Sahara
 black

160183 für Dampfbügelleisen SteamWorks
 schwarz
 for steam iron SteamWorks
 black

Für Sahara oder SteamWorks
Hotel-Bügeleisen

For Sahara or SteamWorks
Hotel Irons

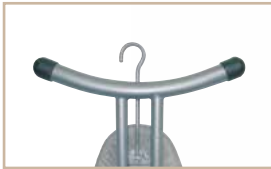

Klappbarer Aufhängehaken
Fold-away suspension hook



EU-Schuko-Elektroanschluss mit
Netz Kabel und Schweizer Stecker
Integrated EU Schuko socket and
extension cord with Swiss plug

E-ZEE CONCEPT

Bügelbrett mit Bügeleisenablage
Feuerfester, gepolsterter Bezug
Höhenverstellbar bis 89 cm
Stabiles Gestell mit Transportsicherung
Material Gestell: Stahlrohr
Pulverbeschichtung, silber

Ironing board with iron rest
Anti-Fire cover with foam underlay
Height adjustable up to 89 cm
Sturdy frame with transport safety lock
Material legs: tubular steel
Powder coated silver finish

Gewicht / Weight

Bügelbrett / Board E-Zee	4,7 kg
Bügeleisen / Iron Sahara	0,8 kg
Bügeleisen / Iron SteamWorks	1,1 kg

160176 E-ZEE SAHARA
Bügelbrett mit Trockenbügeleisen
Ironing board with dry iron

160168 E-ZEE STEAMWORKS
Bügelbrett mit Dampfbügeleisen
Ironing board with steam iron

160149 E-ZEE
Bügelbrett
Ironing board

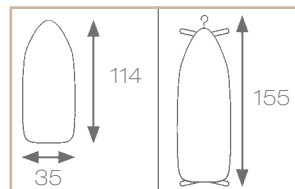



On-Board Hotel Safety Holders

Die festmontierte Halterung wurde für die Gewährleistung von maximaler Effizienz, Sicherheit und Diebstahlschutz entwickelt. Das Bügeleisen ist an der Halterung und diese wiederum am Bügelbrett fixiert. Hitzebeständige und kratzfeste Stoßfänger aus Silikon schützen die Keramiksohle vor Kratzern. Der Kabelhalter ermöglicht eine saubere Aufbewahrung. Durch das festsitzende Bügeleisen kann das Brett problemlos hängend aufbewahrt werden.

Fixed holder design is engineered to provide maximum efficiency and security. Iron is firmly secured to the holder which is fixed in place to the board. Heat and scratch resistant silicone bumpers protects the ceramic soleplate from scratching. Theft-proof reel design provides neat wind-up cable storage. Irons are secured safely in place for easy vertical cupboard stowing.





A Variety of Choices
for a Variety of Needs

On-Board Fixed Holder Design

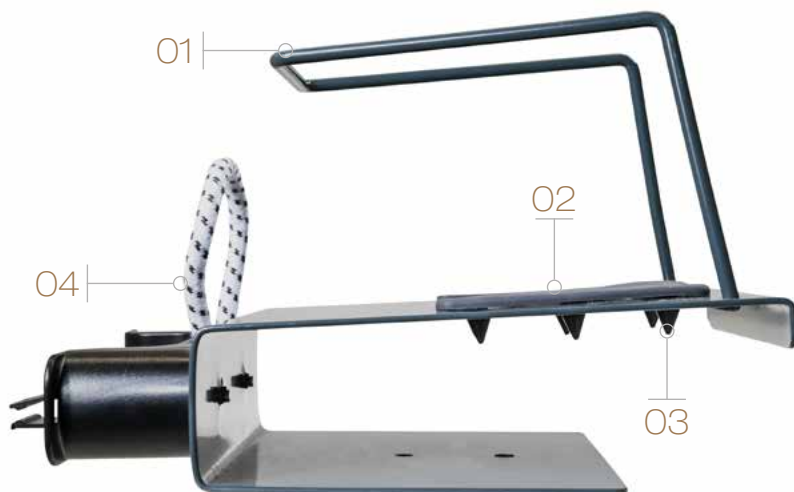

- 01. Passend für Trockenbügelseisen SAHARA und Dampfbügelseisen STEAMWORKS
Accommodates both SAHARA dry Iron and STEAMWORKS steam iron
- 02. Bügelseisen liegt geschützt in der Halterung auf rutschfesten, hitzebeständigen Silikonstreifen
Iron rests securely in place on heat resistant non-slip silicone bumpers
- 03. Austauschbare Silikonstreifen sind fixiert durch überstehende Noppen
Replaceable bumpers are fastened to the holder via soft-pointed silicone inserts
- 04. Diebstahlsicher - Bügelseisenkabel wird durch die Halterung fest mit Bügelbrett verbunden
Theft protection – cable secured through the holder/board



Integrierter Kabelhalter mit Kabelklemme
für eine saubere einfache Aufbewahrung
Integrated Cable Reel and Clip for neat
easy storage



Elektroanschluss mit Netzkabel
Integrated Schuko extension cord



Zur Montage an Tischbügelbrett MINI-MEEE,
Bügelbrett MI-PRO und MINI-MAX

Holder thru-bolted directly onto Aliseo boards:
MI-PRO, MINI-MAX, MINI-MEE

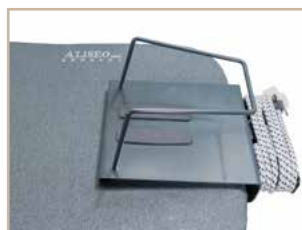

Bügeleisen ist zur Schrankaufbewahrung in
hängender Position an seinem Platz gesichert

Irons are secured safely in place for board
storage in hanging position





160201 MI-PRO SAHARA
Bügelbrett mit Sicherheitshalterung
und Trockenbügelseisen
Ironing board with safety holder
and dry iron

160204 MI-PRO STEAMWORKS
Bügelbrett mit Sicherheitshalterung
und Dampfbügelseisen
Ironing board with safety holder
and steam iron

160213 MI-PRO
Bügelbrett ohne Sicherheitshalterung
Ironing board without safety holder

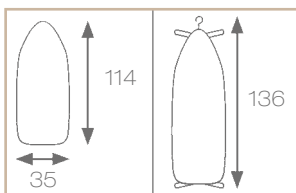

Gewicht / Weight

Bügelbrett / Board Mi-Pro	4,6 kg
Halterung / Holder	1,0 kg
Bügelseisen / Iron Sahara	0,8 kg
Bügelseisen / Iron SteamWorks	1,1 kg
Gesamt / Total	6,4 / 6,7 kg

**Bügelseisen ist in hängender Position
an seinem Platz gesichert**

Irons are secured safely in place for
board storage in hanging position



Für Sahara oder SteamWorks
Hotel-Bügeleisen

For Sahara or SteamWorks
Hotel Irons



MI-PRO

Bügelbrett mit Sicherheitshalterung
Feuerfester, gepolsterter Bezug
Höhenverstellbar bis 85 cm
Elektroanschluss mit Netzkabel
Klappbarer Aufhängehaken
Stabiles Gestell mit Transportsicherung
Material Gestell: Stahlrohr
Pulverbeschichtung, dunkelgrau

Ironing board with fixed safety iron holder
Anti-Fire cover with foam underlay
Height adjustable up to 85 cm
Integrated Schuko extension cord
Fold-away suspension hook
Sturdy frame with transport safety lock
Material legs: tubular steel
Powder coated dark grey finish



EU-Schuko-Elektroanschluss mit
Netzkabel und Schweizer Stecker

Integrated EU Schuko socket and
extension cord with Swiss plug



Minimum Profile - Maximum Board Space

Speziell entwickelt für die Aufbewahrung in kleinen Schränken

Specifically engineered for small cabinet storage



160207

MINI-MAX SAHARA
Bügelbrett mit Sicherheitshalterung
und Trockenbügelseisen
Ironing board with safety holder
and dry iron

160210

MINI-MAX STEAMWORKS
Bügelbrett mit Sicherheitshalterung
und Dampfbügelseisen
Ironing board with safety holder
and steam iron

160216

MINI-MAX
Bügelbrett ohne Sicherheitshalterung
Ironing board without safety holder

Gewicht / Weight

Bügelbrett / Board Mini-Max	4,7 kg
Halterung / Holder	1,0 kg
Bügelseisen / Iron Sahara	0,8 kg
Bügelseisen / Iron SteamWorks	1,1 kg

Gesamt / Total 6,5 / 6,8 kg

Für Sahara oder SteamWorks
Hotel-Bügeleisen
For Sahara or SteamWorks
Hotel Irons



EU-Schuko-Elektroanschluss mit
Netzkabel und Schweizer Stecker
Integrated EU Schuko socket and
extension cord with Swiss plug

MINI-MAX

Bügelbrett mit Sicherheitshalterung
Feuerfester, gepolsterter Bezug
Höhenverstellbar bis 78 cm
Elektroanschluss mit Netzkabel
Klappbarer Aufhängehaken
Stabiles Gestell mit Transportsicherung
Material Gestell: Stahlrohr
Pulverbeschichtung, dunkelgrau

Ironing board with fixed safety iron holder
Anti-Fire cover with foam underlay
Height adjustable up to 78 cm
Integrated Schuko extension cord
Fold-away suspension hook
Sturdy frame with transport safety lock
Material legs: tubular steel
Powder coated dark grey finish

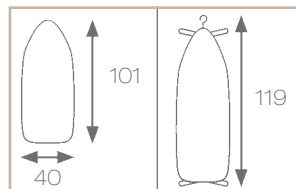

MINI-MEEE

Für Sahara oder SteamWorks
Hotel-Bügeleisen

For Sahara or SteamWorks
Hotel Irons



MINI-MEEE

TISCHBÜGELBRETT
Mit Sicherheitshalterung
Feuerfester, gepolsterter Bezug
Klappbarer Aufhängehaken
Material Gestell: Stahlrohr
Pulverbeschichtung, schwarz

TABLE TOP IRONING BOARD
With fixed safety iron holder
Anti-Fire cover with foam underlay
Fold-away suspension hook
Material legs: tubular steel
Powder coated black finish



Stabiles Gestell mit
Transportsicherung
Sturdy frame with
platform safety lock

160195 MINI-MEEE SAHARA
Tischbügelbrett mit Sicherheitshalterung
und Trockenbügeleisen mit Schweizer Stecker
Table top ironing board with safety holder
and dry iron with Swiss plug

160198 MINI-MEEE STEAMWORKS
Tischbügelbrett mit Sicherheitshalterung
und Dampfbügeleisen mit Schweizer Stecker
Table top ironing board with safety holder
and steam iron with Swiss plug







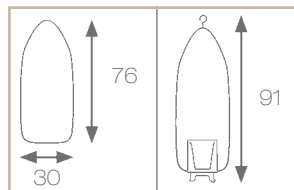

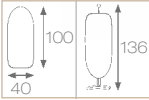

160188 MINI-MEEE
Tischbügelbrett ohne Sicherheitshalterung
Table top ironing board without safety holder

Gewicht / Weight

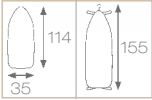
Bügelbrett / Board Mini-Meee	1,9 kg
Halterung / Holder	1,0 kg
Bügeleisen / Iron Sahara	0,8 kg
Bügeleisen / Iron SteamWorks	1,1 kg
Gesamt / Total	3,7 / 4,0 kg



OVERVIEW

	SURF	E-ZEE
<p>HANG-UP</p>  <p>160130 für Trockenbügelleisen Sahara for Dry Iron Sahara</p> <p>160183 für Dampfbügelleisen SteamWorks for Steam Iron SteamWorks</p>	  <p>160132 Bügelbrett Surf Ironing Board Surf</p>	  <p>160111 Bügelbrett E-Zee Ironing Board E-Zee</p>
 <p>SAHARA</p> <p>160172 Trockenbügelleisen Sahara Dry Iron Sahara</p>	 <p>160178 Bügelbrett Surf & Sicherheitshalterung & Trockenbügelleisen Sahara Ironing Board Surf & Safety Cradle & Dry Iron Sahara</p>	 <p>160175 Bügelbrett E-Zee & Trockenbügelleisen Sahara Ironing Board E-Zee & Dry Iron Sahara</p>
 <p>STEAMWORKS</p> <p>160162 Dampfbügelleisen SteamWorks Steam Iron SteamWorks</p>	 <p>160164 Bügelbrett Surf & Sicherheitshalterung & Dampfbügelleisen SteamWorks Ironing Board Surf & Safety Cradle & Steam Iron SteamWorks</p>	 <p>160167 Bügelbrett E-Zee & Dampfbügelleisen SteamWorks Ironing Board E-Zee & Steam Iron SteamWorks</p>

MI-PRO

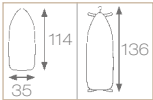

160212

Bügelbrett Mi-Pro
Ironing Board Mi-Pro

MINI-MAX

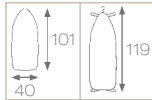

160215

Bügelbrett Mini-Max
Ironing Board Mini-Max

MINI-MEEE

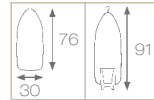

160188

Tisch-Bügelbrett Mini-Meee
Table Top Ironing Board Mini-Meee



160200

Bügelbrett Mi-Pro
& Sicherheitshalterung
& Trockenbügelleisen Sahara
Ironing Board Mi-Pro
& Fixed Safety Holder
& Dry Iron Sahara



160206

Bügelbrett Mini-Max
& Sicherheitshalterung
& Trockenbügelleisen Sahara
Ironing Board Mini-Max
& Fixed Safety Holder
& Dry Iron Sahara



160194

Tisch-Bügelbrett Mini-Meee
& Sicherheitshalterung
& Trockenbügelleisen Sahara
Table Top Ironing Board Mini-Meee
& Fixed Safety Holder
& Dry Iron Sahara



160203

Bügelbrett Mi-Pro
& Sicherheitshalterung
& Dampfbügelleisen SteamWorks
Ironing Board Mi-Pro
& Fixed Safety Holder
& Steam Iron SteamWorks



160209

Bügelbrett Mini-Max
& Sicherheitshalterung
& Dampfbügelleisen SteamWorks
Ironing Board Mini-Max
& Fixed Safety Holder
& Steam Iron SteamWorks



160197

Tisch-Bügelbrett Mini-Meee
& Sicherheitshalterung
& Dampfbügelleisen SteamWorks
Table Top Ironing Board Mini-Meee
& Fixed Safety Holder
& Steam Iron SteamWorks

THE RACK When you need it





Mahagoni, gebeizt
Mahogany, stained

KOFFERABLAGE

Schwarze Gurtbänder
Material: Holz, Kiefer

Mit Rückentlehne
geklappt (B x H x T)
63 x 83 x 11 cm

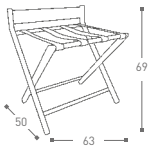

Ohne Rückentlehne
geklappt (B x H x T)
63 x 72 x 11 cm



LUGGAGE RACK

With black straps
Material: wood, pine

With back
folded (W x H x D)
63 x 83 x 11 cm

080075 gebeizt, Mahagoni
mahogany stained

Without back
folded (W x H x D)
63 x 72 x 11 cm

080072 Kiefer, natur
natural pine

080073 gebeizt, Mahagoni
mahogany stained



Kiefer, natur
natural pine



KOFFERABLAGE

Schwarze Gurtbänder
Material: Stahlrohr

Mit Rückenlehne
geklappt (B x H x T)
68 x 85 x 10 cm

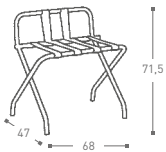

Ohne Rückenlehne
geklappt (B x H x T)
68 x 65 x 9 cm

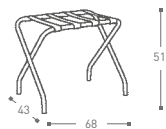

LUGGAGE RACK

With black straps
Material: steel tube

With back
folded (W x H x D)
68 x 85 x 10 cm

080053 chrom
chrome

Without back
folded (W x H x D)
68 x 65 x 9 cm

080055 chrom
chrome





KOFFERABLAGE

Mit Rückentlehne
Beige Gurtbänder
Material: Edeltstahl
Oberfläche, verchromt

geklappt (B x H x T)
67,5 x 89 x 9 cm

LUGGAGE RACK

With back
Beige straps
Material: stainless steel
Surface, chrome plated

folded (W x H x D)
67,5 x 89 x 9 cm



080069

chrom
chrome